

Operating Instructions  
Laboratory Glassware  
Washer  
PG 8536

---

To prevent accidents  
and machine damage  
read these instructions  
**before**  
installation or use.

en - US

M.-Nr. 07 890 492



<b>IMPORTANT SAFETY INSTRUCTIONS</b>	5
<b>Function of the laboratory glassware washer</b>	10
User profiles	10
<b>Guide to the lab washer</b>	11
Electronic controls	12
Display	14
<b>Context menu</b>	16
Change the display language	17
Change the operating level	18
Delay start	20
Current faults	22
Reactivate	22
<b>Opening and closing the door</b>	23
Electric door lock	23
Opening the door with the emergency release	24
<b>Water softener</b>	25
Setting the water softener	25
Reactivation display	25
Reactivating the water softener	26
Filling the salt container	27
Inserting the salt container	27
Reactivating the water softener	28
<b>Automatic mobile unit recognition</b>	29
<b>Spray arm monitoring</b>	30
<b>Use</b>	31
Loading the machine	31
Process validation	31
Spring adapter water connection	33
Height adjustable top basket	33
<b>Effects of Processing Chemicals</b>	36
<b>Adding liquid detergents and neutralizers</b>	41
Dispensing systems	42

# Contents

---

<b>Operation</b> . . . . .	44
Turning On . . . . .	44
Reset button . . . . .	44
Starting a program . . . . .	44
Program sequence . . . . .	45
End of program . . . . .	45
Turning off . . . . .	45
Cancel program . . . . .	46
Interrupting a program . . . . .	47
<b>Process documentation</b> . . . . .	48
<b>Maintenance</b> . . . . .	49
Routine checks . . . . .	49
Cleaning the filters in the wash cabinet . . . . .	50
Cleaning the spray arms . . . . .	52
Cleaning the control panel and glass door (optional) . . . . .	53
Cleaning the exterior . . . . .	53
Cleaning the wash cabinet . . . . .	53
Cleaning the door seal . . . . .	53
Baskets and inserts . . . . .	54
Drying unit maintenance . . . . .	55
<b>Frequently asked questions</b> . . . . .	57
Cleaning the water intake filters . . . . .	58
<b>After sales service</b> . . . . .	59
<b>INSTALLATION INSTRUCTIONS</b> . . . . .	61
<b>Installation</b> . . . . .	62
<b>Electrical connection</b> . . . . .	63
<b>Plumbing</b> . . . . .	64
Water connection . . . . .	64
<b>Technical Data</b> . . . . .	67
<b>Caring for the environment</b> . . . . .	68

# IMPORTANT SAFETY INSTRUCTIONS

This machine conforms to current safety requirements. However, inappropriate use can lead to personal injury and property damage. Read the operating instructions carefully before using this machine.

Keep these instructions in a safe place and pass them on to any future user.

## Use

- ▶ This machine is designed for commercial use and for specialized applications only, as described in these Operating Instructions. Do not use for purposes other than those for which it was designed, as this could be dangerous.
- ▶ This machine is intended for indoor use only.

## Please pay attention to the following notes to maintain safe procedures.

- ▶ The machine should be commissioned and maintained only by a Miele Service Technician. Good laboratory guidelines should be followed. Repairs by unqualified persons could be dangerous.
- ▶ Do not install the machine in an area where a danger of explosion or freezing may be present.
- ▶ Be certain this appliance is properly installed and grounded by an authorized technician. To guarantee the electrical safety of this appliance, continuity must exist between the appliance and an effective grounding system. It is imperative that this basic safety requirement be met. If there is any doubt, have the electrical system checked by a qualified technician.
- ▶ A damaged or leaking machine is dangerous. Disconnect the machine from the power supply immediately and contact Miele.
- ▶ Personnel operating the machine should be trained regularly. Children and untrained personnel must not be allowed access to the machine or its controls.
- ▶ Take care when handling liquids such as detergents, neutralizing agents, wetting agents and rinse aids. These may contain irritant or corrosive ingredients, acids or alkalis. Wear protective gloves and goggles. The manufacturer's safety conditions must be observed at all times.

# IMPORTANT SAFETY INSTRUCTIONS

---

▶ The lab washer is only designed to operate with water and the appropriate processing chemicals. The machine must NOT be operated with organic solvents or flammable liquids. This may cause an explosion or damage to rubber and plastic components, which in turn allows liquid substances to leak out.

▶ The water in the machine must not be used as drinking water.

▶ Do not sit or lean on an open door. The machine could tip and be damaged or cause injury.

▶ Be careful when sorting items with sharp pointed ends. Position them in the machine so that you do not hurt yourself or create a danger for others.

▶ When using this machine regard the high temperatures and be especially careful not to scald or burn yourself. When opening the door bypassing the electrical lock, a danger of burning, scalding and corrosion exist. Let mobile units, inserts and cleaned items cool before touching them. Any water which may remain in containers will be very hot and must be emptied into the wash cabinet.

▶ If toxic chemical substances can form in the wash water during processing (e.g. aldehydes in the disinfection agent), the door seal and, if applicable, the function of the steam condenser must be checked regularly. In this event, opening the door of the lab washer during a program interruption is particularly hazardous.

▶ If you are exposed to toxic vapors or processing chemicals, consult the manufacturer's material safety data sheets for emergency procedures.

▶ Mobile units, baskets, inserts and the load itself must be allowed to cool before removal. The dispensing parts should also be drained of any residual water.

▶ After drying with the drying unit, open the door to allow the load, mobile unit, baskets and inserts to cool down.

▶ Do not touch the heating element if you open the door at the end of the program. You may suffer burns even several minutes after the program has ended.

▶ Never clean the machine near or with a water or high pressure hose.

▶ Before servicing, disconnect the power supply by either removing the fuse, unplugging the unit or manually "tripping" the circuit breaker.



Mount on non-combustible floors only!

# IMPORTANT SAFETY INSTRUCTIONS

**The following points should be observed to assist in maintaining quality standards and to avoid damage to the loads being cleaned.**

▶ Only authorized persons may interrupt a program, and only in exceptional cases.

▶ Use of a chemical disinfectant at moderate temperatures (for example 149°F / 65°C or lower) do NOT fulfill the official requirements for disinfection pursuant to FDA regulations. Always note their specifications for handling, application conditions and efficacy. The operator is responsible for the use of any such thermo-chemical processes.

▶ If the machine is being used for disinfection ordered by the authorities, the steam condenser and its connections to the rinsing chamber and outlet discharge must be disinfected before any repair or exchange.

▶ Only use process chemicals that are approved by their manufacturer for the application involved. Any negative effects on labware and the washer itself are the liability of the chemical manufacturer.

▶ Use only Miele approved cleaning agents with this machine. Use of unsuitable cleaning agents could adversely affect the components of the machine. Damages resulting from using unsuitable cleaning agents are not covered by the warranty.

▶ Pre-treating (e.g. with cleaning agents), certain soiling and cleaning agents with a chemical interaction, can cause foam. For pre-treatment and/or cleaning only use low-sudsing detergents which have been approved by Miele. Suds can have an adverse effect on the operation of the machine.

▶ The process must be set so that no foam escapes the wash compartment. Escaping foam jeopardizes the safe operation of the lab washer.

▶ The process must be checked regularly in order to detect any foaming.

▶ In order to prevent damage to the lab washer and any accessories through processing chemicals or dirt as well as any interaction between them, see "Effects of Processing Chemicals".

▶ When a chemical additive is recommended, the manufacturer of the machine takes no responsibility for the effect of the chemical on the items being cleaned.

▶ In critical applications where very high requirements have to be met, it is strongly recommended that all the relevant factors for the process, such as cleaning agent, quality of water, etc. are discussed with the Miele Applications Specialists.

# IMPORTANT SAFETY INSTRUCTIONS

---

- ▶ If the cleaning result is subject to particularly stringent requirements (e.g. chemical analysis), a regular quality control test should be carried out by the user to ensure that the required standards of cleanliness are being achieved.
- ▶ The mobile units and special inserts should only be used for their specific application.
- ▶ Empty any containers or utensils before arranging them in the machine.
- ▶ Do not allow any remains of acids, solvents or corroding ferrous material, and in particular hydrochloric acid or chloride solutions to get into the wash cabinet. Similarly avoid any materials with a corrosive effect. The presence in compounds of any solvents should be minimal, (especially those in hazard class A1).
- ▶ To avoid any corrosion damage ensure that solutions or steam containing hydrochloric acid do not come in contact with the stainless steel casing of the machine.
- ▶ After work on the mains water supply, the water supply line to the machine must be vented. Machine components may otherwise be damaged.
- ▶ Please follow the installation advice in these instructions and the separate Installation Instructions.

## Using accessories

- ▶ Only Miele accessories should be connected to this machine. Consult a Miele Application Specialist on the type and application of such equipment.
- ▶ Only Miele mobile units, modules and inserts should be used. If equipment from another manufacturer is used, Miele cannot ensure the cleaning results. Damage or injury caused by this are excluded from the warranty.

## Please note the following symbols on the machine:

Caution : See the Operating Instructions!



Caution : Danger of electric shock!





# IMPORTANT SAFETY INSTRUCTIONS

---

## **Disposal of an old appliance**

► When discarding an Industrial cleaner, disconnect it from the power supply and cut off the power cord. For environmental and safety reasons ensure the machine is completely drained of any residual water and cleaning agent. (Observe safety regulations and wear safety goggles and gloves). Make the door lock inoperative or remove the door completely, so that children cannot accidentally shut themselves in. Make appropriate arrangements for the safe disposal of the machine. Machines with a tank system: remove the water from the tank before disposing the machine.

# **SAVE THESE INSTRUCTIONS**

# Function of the laboratory glassware washer

---

The Laboratory Glassware Washer is designed for high-throughput, centralized wash areas. This unit is ideal for cleaning both large volumes of small items, and difficult to clean large items.

## Typical applications include:

- laboratory equipment for research and production,
- laboratory equipment for analytical and preparation applications,
- microbiology and biotechnology labware,

Labware can include anything from evaporation dishes to centrifuge tubes.

In these operating instructions, the general terms labware and glassware are used to cover a range of laboratory equipment and medical items.

For standardized results, it is preferable to machine-wash lab instruments and equipment.

The cleaning parameters should always be optimally matched to the type of soiling and labware involved.

The processing chemicals used also should be matched to the particular cleaning needs / analysis / analytical methods involved.

The use of a suitable carrier (mobile unit, module, insert etc.) is important to ensure the adequate cleaning of instruments and products.

## User profiles

### Users

For daily routine tasks, the operating personnel must be introduced to the basic functions and the loading of the lab washer and should be trained regularly. They need basic knowledge of the machine-based processing of medical devices.

Daily routine work is organized in operating levels A and C.

### Administrators

Advanced knowledge of the machine-based processing of medical devices is required for more complex tasks such as program interruption or program cancellation.

These tasks are completed in operating level B.

### Technical service

Further device-specific knowledge regarding modifications of the cleaning processes or adjustments to the lab washer to specific accessories or the conditions at the site is required.

Contact Miele for additional information of the machine-based processing of medical devices, the process technology and applicable standards and legislation.

Service tasks and validations are completed in operating level D.

# Guide to the lab washer

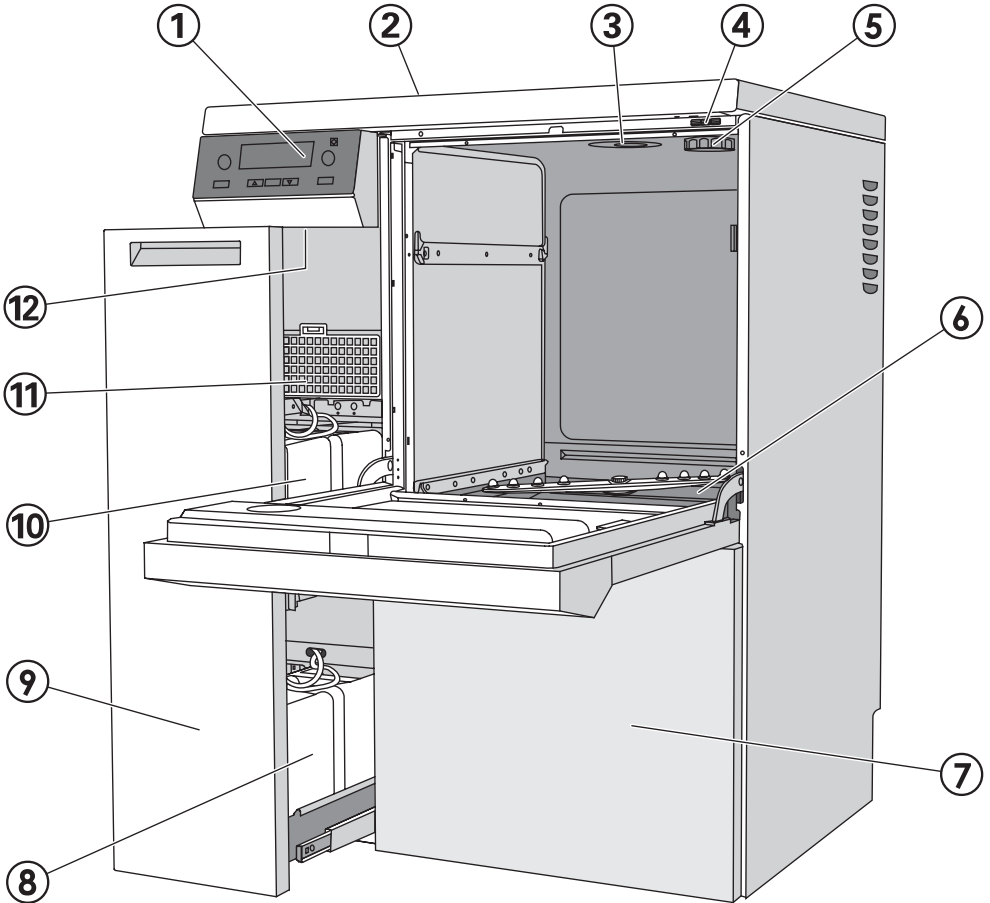

- ① Control panel
- ② Serial interface  
(rear side, top left behind cover plate)
- ③ Water intake
- ④ Sensor access for validation
- ⑤ Salt container port  
(water softener)
- ⑥ Filter combination
- ⑦ Service panel
- ⑧ Containers for DOS 2 and DOS 4  
dispensing systems (optional)
- ⑨ DOS drawer
- ⑩ Containers for neutralizer (red) and  
liquid detergent (blue)
- ⑪ Drying unit
- ⑫ Reset button

# Guide to the lab washer

---

## Electronic controls

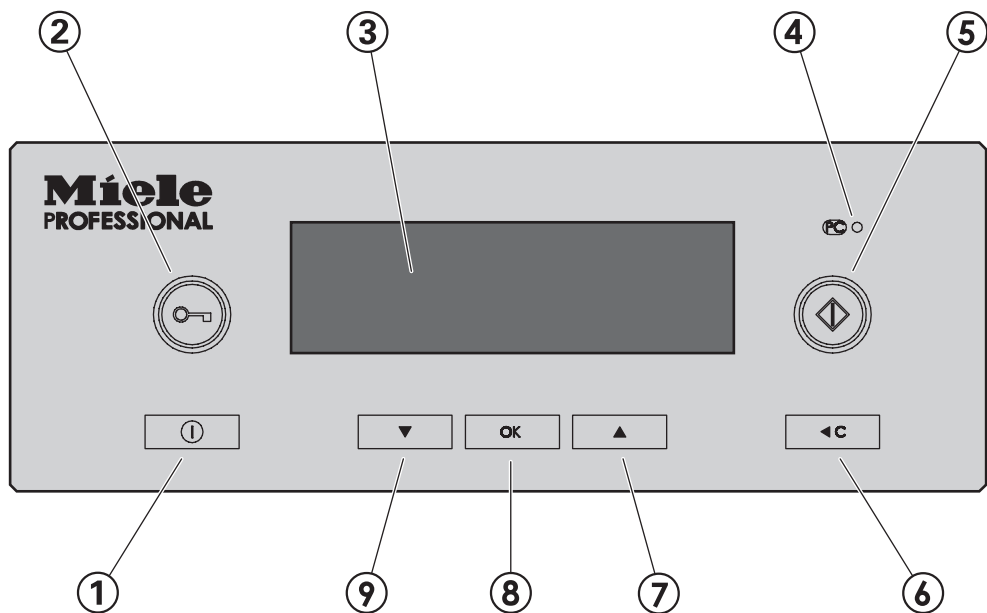

① **On/Off button** ①

turn washer on and off

② **Door button**

door release

③ **Display**

If the washer is not in use, the display automatically turns off after approx. 10 min.

- To turn the display back on, touch any button.

Fault messages are shown in the display, together with a corresponding number. See the "Programming Manual" for more information.

④ **Optical Interface** 

used by Miele Service Technicians

⑤ **Start button** 

start a program

⑥ **Clear button** 

- return to the previous level
- discard entry
- cancel a program

⑦ and ⑨ **Selection buttons** ▲ ▼

- shift position of marking in display
- changed marked value
- scroll
- retrieve menu
- display user-defined operating parameters during program operation

⑧ **OK Button**

- confirm marked menu item or selected value,
- erase fault messages,
- erase dialogue messages,
- access A<sub>0</sub> graph during program operation.
- call up temperature progression during program.

# Guide to the lab washer

---

## Display

Depending on the operating level, the following choices are available in the display:

- a program / the program overview
- the programming menu
- the settings menu 

In the **Settings**  menu, you can adjust the Profitronic controls to suit various requirements. For additional information, please see the separate Programming Manual.

### Example for a selection list

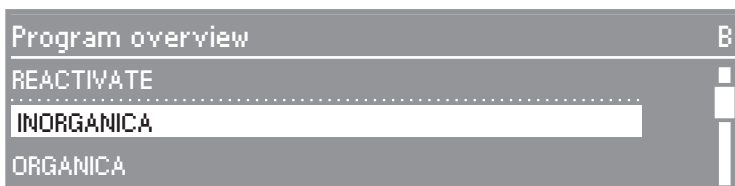



Use the   buttons to move through the menu items.

The highlight in the display can be moved using  .

Use the **OK** button to confirm messages or settings. You can also move to the next menu or another menu level.

To select a menu item, mark it using  , confirm with **OK**.

A maximum of three menu items or selections can be shown in the display. A scroll bar at the right of the display shows that additional menu items or selections are available. Use the selection buttons   to display them.

A dashed line signals the end of the list. The last entry on the list is above the line, the first entry is below it.

## Example of a program sequence display



While a program is running, the following appears in the display:

- the program display
- the operating level
- the program block
- the water temperature  
(or the air temperature in the program block "Dry")
- the estimated time remaining or the program time completed so far
- any fault messages or notices

## Context menu

---

Certain functions are available through the context menu at any time, regardless of the operating level:

- change display language
- change operating level,
- enter Delay Start
- for convertible washers:  
change heating type,
- loading package to arrange barcode scanner.

The current fault messages can be shown in operating level D (if available).

- To enter the context menu, press and hold the ▲▼ buttons at the same time.

The context menu appears in the display:





Use the buttons ▲▼ to move through the menu items.





### Change the display language



You can use the context menu to change the language used in the display.

This setting is stored until the washer is switched off with the  button or the main switch.

The language set under "Settings - Language " does not change. All reports and print-outs will continue to be completed in the system language.

- To select the menu item **Change display language** use  , confirm with **OK**.
- Select the desired language and confirm with **OK**.

The selected language appears in the display.

- To leave the context menu, select  **C**.
- The  symbol indicates the **Change display language** setting.  
If you accidentally select an unfamiliar language, simply select the menu item with  and select the desired language.

# Context menu

## Change the operating level

Four operating levels are available for selection.

Operating levels	Authorized access for :
A and B	selecting from a list of approved programs.
C	automatic program assignment by mobile unit code.
D	open program selection through the Program overview, Programming and Settings  menus.

The context menu can be used to switch between operating levels.

To help prevent unauthorized access to the settings, a code is required to change operating levels.

To change the codes for existing users, or to enter new users, you must be a registered administrator. The **Administrator** can be registered by Miele.

- Press and hold the ▲ ▼ buttons for at least 3 seconds.

The context menu appears in the display:



- Select the menu item **Change operating level**, confirm with **OK**.



- Select the user group and confirm with **OK**.
- Enter the required code.



- Select **▲▼** to change the numbers.
- Confirm with **OK**.

Repeat same process for each number.

Once complete the display will switch to the selected operating level.

- Select **◀C** to exit the Context menu.

- The message can be canceled with **OK**.

Repeat the process to change the operating level.

# Context menu

---

## Delay start

The start time for a program can be pre-selected.

- Select **Delay start** and confirm.
- To activate the Delay start option, go to the menu item **Activate** and select **Yes** .

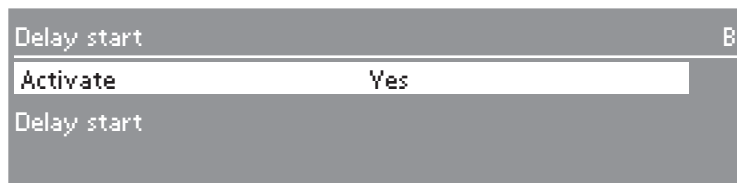

- To use this feature, select **Delay start** and confirm.

The start time menu will appear.



- Select **▲▼** to enter the desired start time, then confirm.
- Press and hold the **◀C** until the **Main menu** appears in the display.
- Select **Program overview** to select a program.



- Select a program.
- Start with **◊**.

The selected program, the delay start time, the current time of day, and the time remaining until the program starts are displayed.



The selected program automatically starts at the delay start time.

- To cancel the automatic program start, press **◀C**.

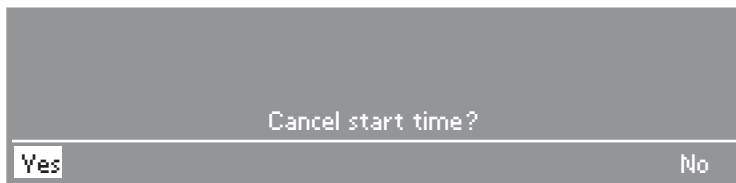

- Select **Yes** and confirm.
- The automatic program start is canceled. The display reverts to the program overview. The **Delay Start** option is canceled.  
If you select **No**, the Delay Start option will continue.
- Once the program has run through, the function **Delay Start** is automatically deactivated.
- The function **Delay Start** can also be deactivated independent of a program start. To do so, go to the **Delay Start** menu, and set the parameter **Activate** to **No**.

# Context menu

---

## Current faults

This menu option is displayed in operating level D if there is currently at least one fault.

The current fault messages can be shown in operating level D.

- Select the menu item and confirm with **OK**.

The current fault messages are displayed.

- Use **OK** to scroll through the fault messages.
- To leave the context menu, select **◀C**.

## Reactivate

This menu option is shown in operating level C only as long as no program is running.

All other steps in connection with the water softener are described in the chapter "Water softener".

# Opening and closing the door

---

## Electric door lock

The machine is equipped with an electric door lock.

The door can only be opened when:

- the machine is connected to the electrical supply,
- the machine is turned on with the  button, and
- no wash or disinfection program is running.

## Opening the door

- Press the  door button, and holding onto the door grip open the door.

 Do not touch the heating element if you open the door at the end of the program. You may suffer burns even several minutes after the program has ended.

## Closing the door

- Lift the door upwards and push until it clicks shut.

# Opening and closing the door

## Opening the door with the emergency release

 The emergency release should only be used when the door cannot be opened normally, e.g. in the case of a power failure.  
Caution with DESIN programs – see Important Safety Instructions.

 When opening the door bypassing the lock, a danger of burning, scalding, corrosion and inhalation of toxic fumes exist.

Do not touch the heating element if you are interrupting a program by opening the door. Danger of burns.

- Disconnect the machine from the electrical supply.

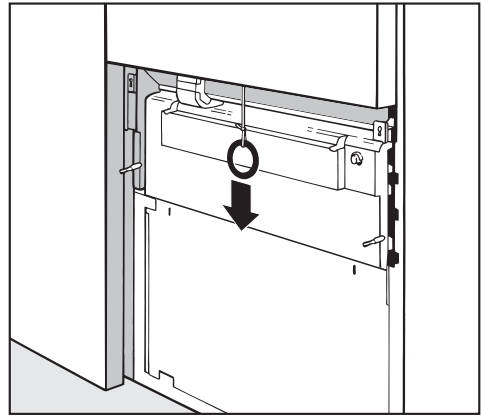

- Remove the service panel and pull the ring of the emergency door release down.

 If there is lots of hot water in the wash cabinet and the door is closed quickly, hot water may spray out, causing danger of burning or scalding.



For good cleaning results, the machine requires soft (calcium poor) water. If the mains water is hard, white deposits will form on the load and the walls of the rinsing chamber. Softening is required if the hardness of the mains water exceeds 4 °d (4 gr/gal). This takes place automatically in the built-in softener.

- The softener requires regeneration salt.
- The machine must be programmed exactly to the hardness of your mains water supply.
- Information on the exact hardness of the mains water can be obtained from your local water authority.

The machine is set at the factory for a water hardness level of 19 °d (19 gr/gal).

If the water supply is harder or softer than the factory setting (including below 4 °d [4 gr/gal (0.7 mmol/L)], the setting will need to be changed in the electronic control.

Your local water authority will advise you on the water hardness in your area.

Where the water hardness fluctuates e.g. between 8 - 17 °d (8 - 18 gr/gal), always program the machine to the higher value, 17 °d (18 gr/gal) in this example.

If there is a fault, it will be helpful to know the water hardness of the local water supply.

Enter the local water hardness level:

\_\_\_\_\_

## Setting the water softener

The water softener must be set by the service technician after installing the machine to reactivate the water softener according to the local water hardness level. See Programming Manual "Operation information - Reactivation".

## Reactivation display

After a certain number of cycles the message REACTIVATION will appear in the display to inform you that the water softener is empty. **Immediately after the program has finished**, reactivation salt must be replenished.

If this cannot be done immediately, and further cleaning cycles have been carried out, the reactivation process will need to be carried out twice in a row.

# Water softener

---

## Reactivating the water softener

Only special, coarse-grained reactivation salt\* should be used in this machine.

\*Available from Miele's Professional Customer Service Department. Please see back page for more information.

 Do not use other types of salt, e.g. table salt, agricultural or gritting salt. These could contain components which are insoluble in water and could damage the water softener. If in doubt, consult Miele's Professional Department.

The salt reservoir holds approx. 4.4 lb (2 kg) of salt.

 Inadvertently filling the salt reservoir with detergent will damage the water softener. Before filling, make sure that you are using **reactivation salt**.

## Filling the salt container

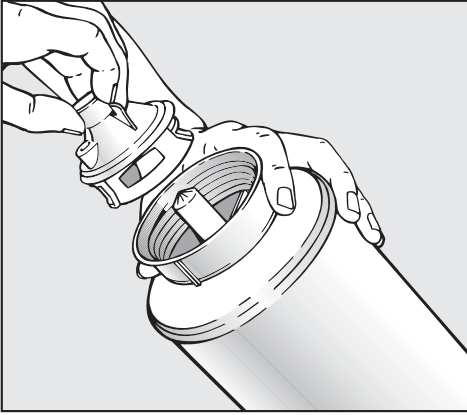

- Unscrew and remove the filter insert from the salt container.
- Fill the salt container with reactivation salt and replace the filter insert.

## Inserting the salt container

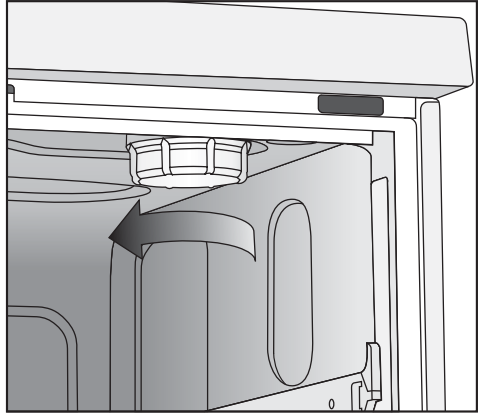

- Remove any mobile units from the cabinet.
- Unscrew the plastic cap located at the top right-hand side of the cabinet.

 A small amount of residual water will be in the cap. Take care as it may be hot from the previous program.

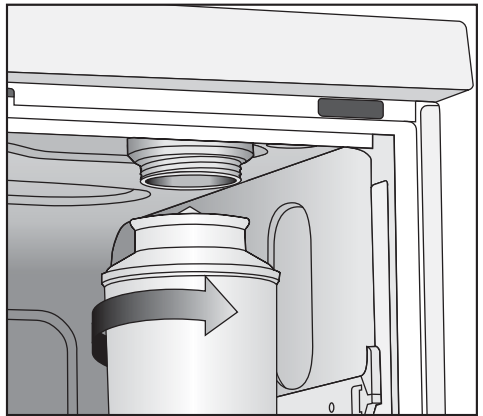

- Screw the salt container firmly onto the socket.

# Water softener

---

## Reactivating the water softener

- Close the door.
- Select and start the **REACTIVATION** program.

In operating level **C**, you must start the reactivation using the context menu. To do so:

- Open the context menu.
- Select the menu item **REACTIVATION** and confirm with **OK**.

The system will automatically perform the reactivation.

The water pressure (flow pressure) must be at least 21 psi (150 kPa). If it is below that or if it fluctuates, the water softener will not work properly. After reactivation, salt remains may still be found in the salt container. To use up the salt remains and to rinse out the water softener, the **REACTIVATION** program must be run again.

- Turn off the lab washer.
- Open the door.
- Carefully unscrew the salt container in order to allow any water pressure to subside. **Do not use force.** If the container cannot be removed manually, contact Miele.
- The salt container must be emptied outside the wash cabinet.

Salt brine and salt residue in the wash cabinet may cause corrosion and must be flushed immediately.

- Screw the softener lid back on.
- Insert the mobile unit.
- Wash and rinse the salt container and the filter cap with clear water.

## Automatic mobile unit recognition

---

The automatic mobile unit recognition feature assigns a program place to a mobile unit. For this to work, the mobile units must be coded with a magnetic strip (with a bit combination). The ML/2 magnetic strip can be purchased separately.

In operating level C, each coded mobile unit is assigned to the corresponding program place.

When a coded unit is inserted into the machine and the lab washer door closes, the automatic mobile unit recognition selects the assigned program.

See the separate "Programming Manual" for information on how to code a mobile unit and assign programs.

 Make sure that no metallic parts or pieces are stuck to the magnetic strip or its underside. Attached metallic objects can cause the coding to be misread or unreadable.

The magnetic strips of the PG 8535/8536 lab washers are **gray**

# Spray arm monitoring

The processing result depends on the rinsing and flushing of all surfaces and hollow spaces of the lab ware with wash water.

One top and one bottom spray arm in the appliance distribute the wash water in the wash cabinet.

When **Spray arm monitoring** is activated, the system will check whether the speeds of the spray arms are maintained within predefined limit values.

## Mobile unit

Mobile units can be fitted with one or several spray arms.

They must be equipped with magnets for the speed monitoring to be functional.

 Spray arm monitoring will only function if the type of mobile unit is coded with a magnetic strip (see the "Programming Manual - Coding a mobile unit").

## Top and bottom baskets

For the PG 8535 / 8536 lab washers, combinations of top and bottom baskets may be used in addition to the mobile units.

The top baskets can be also fitted with spray arms using speed monitoring. This does not require a magnetic strip.

As per factory setting, spray arm monitoring for the top basket is deactivated.

This setting may be kept if only top baskets without spray arm are used.

If top baskets with and without spray arms are used and spray arm monitoring for the top basket is activated, the following message will appear prior to starting the program:

### **Basket with a spray arm?**

This question can be answered with Yes or No.

Miele Technical Service can deactivate this query if only top baskets with spray arms are used.

## Lab applications

Narrow-necked items, e.g., narrow-necked Erlenmeyer flasks, round flasks, volumetric flasks and pipettes, require the use of injector top or bottom injector baskets.

In the area of lab applications, spray arm monitoring for the top appliance spray arm is only used for some combinations.

Top basket	Bottom basket	Spray arm monitoring
O 175	U 175/1	Yes
O 175	U 184/1	Yes
O 184	U 175/1	No
O 184	U 184/1	No
O 187	U 175/1	Yes
O 187	U 184/1	Yes

The lab washer can be fitted with a variety of mobile units, baskets and inserts, depending on the cleaning application desired.

## Loading the machine

### Removing excess soils

- Empty all containers before loading them into the machine.

 Ensure that no acid or solvent residues, especially hydrochloric acid or chlorides get into the wash cabinet.

## Check before cleaning

- Are the items to clean correctly sorted and connected?
- Are the spray arms clean and can they rotate freely?
- Is the filter combination free of coarse soiling?
- Is the adapter to the water inlet in place?
- Are the spray arms correctly connected?
- Are the detergent and neutralizer containers full?

## Check after cleaning

- Check the cleaning results visually.
- Are the jets and connections securely connected with the mobile unit / inserts?

## Process validation

As a rule, it is the responsibility of the user to ensure that items cleaned in the machine meet the required standards.

# Use

---

## Loading tips

Select mobile units, baskets and inserts appropriate for the application.

- Load the items to be washed so that water can access all surfaces. This ensures that they are properly cleaned.
- Do not place items to be cleaned inside other pieces where they may be concealed.
- Hollow vessels such as beakers, measuring cylinders, flasks, etc. should be inverted and placed in the correct inserts so that water can flow in and out unrestricted. A cover net can be used to reduce the risk of movement during the wash process.
- Use a cover net (e.g. an A 6) or a mesh tray for small items, to secure lightweight items and to prevent them from blocking the spray arms or being caught in the magnetic strip on the automatic mobile unit recognition system.
- Deep based items should be placed at an angle to allow water to run off easily.
- Tall, narrow pieces should be placed in the center of the baskets. This ensures good water coverage.
- Mobile units and baskets with an adapter must engage correctly.
- Engage inserts correctly into the module carts.
- The spray arms must not be blocked by tall items or items which hang in their path. If necessary, manually rotate the arms to test.
- Petri dishes and the similar should be placed in the correct insert with the soiled side facing the center.
- Insert pipettes with the pointed end downwards.
- Quarter inserts should be placed as close to the middle of the unit as possible.
- Glassware should not stick out of the door area.

 Ensure that no acid or solvent residues, especially hydrochloric acid or chlorides, get inside the machine.



## Spring adapter water connection

Make sure that the spring adapter for the water connection engages correctly when a basket or injector unit is inserted in the machine. It must be  $\frac{1}{8}$ " -  $\frac{1}{4}$ " (4-5 mm) higher than the water connection inlet in the machine.

If it is not, adjust the adapter accordingly.

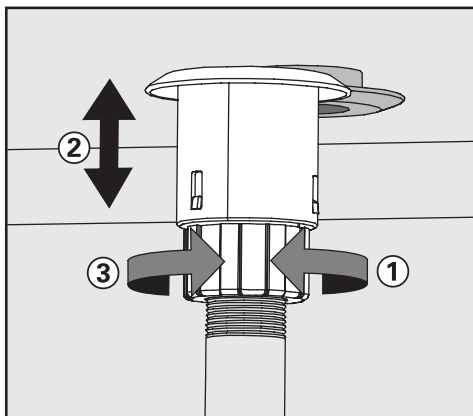

- Loosen the lock ring, ①.
- Push up the adapter, ② ( $\frac{1}{8}$ " -  $\frac{1}{4}$ " (4-5 mm) higher than the water connection inlet in the machine).
- Tighten the lock ring, ③.

## Height adjustable top basket

The upper basket can be adjusted above and below the middle position by  $\frac{13}{16}$ " (2 cm).

Depending on the position of the upper basket and usage of an insert, tall items can be accommodated in the baskets.

On the right hand side the height in the upper basket is limited by the salt container connection.

### To adjust the upper basket:

- Pull the upper basket out all the way, lift from the runners and remove.
- Unscrew the knurled nuts (roller bearings) on both sides of the basket with a suitable wrench, reposition as required.

# Use

---

## Laboratory glassware (LG)

Wide-necked glassware, such as wide necked erlenmeyer flasks and petri dishes or glassware with a cylindrical form, e.g. test tubes, can be cleaned inside and out with the rotating spray arm. General glassware such as beakers, conical flasks, petri dishes, test tubes, etc. can be arranged in full-size, half or quarter inserts in an empty basket with spray arms. Mobile injector units are available for direct injection spraying of narrow necked flasks, pipettes, etc.

The following instructions relate only to basic preparation and loading of glassware.

## Loading the machine

### Removing excess soils

- Empty all glassware before loading into the machine. Take any hygienic measures necessary to avoid infection.

 Ensure that no acid or solvent residues, especially hydrochloric acid or chlorides get into the wash cabinet.

- Remove all agar residues from petri dishes.
- Remove blood clots and residues from test tubes, etc.
- Remove all stoppers, corks, labels, sealing wax residues, etc.
- Small parts such as stoppers and taps should be secured in suitable basket inserts.

### Please note:

- Petri dishes and similar items should be loaded in a suitable insert, with the soiled side facing the middle traverse axis.
- Load pipettes with the tip facing down.
- Quarter segment baskets should be placed at least 1" (3 cm) away from the edge of the mobile unit.

Program	Application
STANDARD	Simple and quick program for labware with low soiling and low demands: <ul style="list-style-type: none"> <li>– for various soiling,</li> <li>– not suitable for denaturing residues, i.e. proteins,</li> <li>– not suitable for acid-soluble residues i.e. metallic salts and amines.</li> </ul>
UNIVERSAL *	General program for labware with low to moderate soiling and average demands: <ul style="list-style-type: none"> <li>– to remove organic residues, i.e. proteins, oils and grease,</li> <li>– soiling due to inorganic residue, i.e. pH 7 water soluble metallic salts,</li> <li>– for preparative and analytic areas.</li> </ul>
INTENSIVE *	Program for moderate to heavy soiling of labware with moderate to high demands: <ul style="list-style-type: none"> <li>– for removal of organic residues, i.e. proteins, oil and grease,</li> <li>– soiling due to inorganic residue, i.e. pH 7 water soluble metallic salts,</li> <li>– for preparative and analytic areas.</li> </ul>
PIPETTES	General program for low to moderate soiling of labware with high demands, uses an increased amount of water: <ul style="list-style-type: none"> <li>– for pipettes.</li> </ul>
PLASTIC	Program for low to moderate soiling and demands on average labware: <ul style="list-style-type: none"> <li>– for temperature sensitive laboratory equipment, i.e. plastic bottles, max. temp. 131°F (55 °C),</li> <li>– for preparative areas,</li> <li>– conditioning for analytics.</li> </ul>
ORGANICA *	Program for moderate to severe soiling and average demands of labware: <ul style="list-style-type: none"> <li>– to remove organic residues, i.e. oils, fats, wax</li> <li>– not suitable for acid-soluble residues i.e. metallic salts and amines.</li> </ul>
INORGANICA	Program for low to moderate soiling and medium to high demands of labware: <ul style="list-style-type: none"> <li>– to remove inorganic residues,</li> <li>– for analytics and water analysis,</li> <li>– for aqueous media with acid-soluble metallic salts, i.e. <math>\text{Ca}_{2+}</math>, <math>\text{Mg}_{2+}</math>, etc.</li> </ul>
OIL * / **	Program for heavy soiling and demands of average labware: <ul style="list-style-type: none"> <li>– for removing oil soiling, i.e. crude oil, synthetic oils and lubricants, fuels and some natural oils,</li> <li>– not suitable for acid-soluble residues, i.e. metallic salts and amines.</li> </ul>

\* The use of oil and grease resistant elastomers is recommended for organic residues containing oils, grease, fat, etc..

\*\* The DOS NA 120 dispensing system is required.

# Effects of Processing Chemicals

General information	
Effects	Action
<p>Damage to elastomer (seals and hoses) or plastic components of the lab washer may cause the materials to swell, shrink, harden or become brittle, possibly causing cracks to form in the materials. This will impair their function, which will generally lead to leaks.</p>	<ul style="list-style-type: none"> <li>– Find and correct the causes of the damage.</li> </ul> <p>See "Connected processing chemicals", "Soiling" and "Reactions between processing chemicals and soils" for more information.</p>
<p>Strong foaming during the program prevents proper cleaning and rinsing of the load. Foam escaping from the wash compartment can result in damage to the lab washer.</p> <p>If foaming occurs, the cleaning process is <b>not</b> standardized and <b>not</b> validated.</p>	<ul style="list-style-type: none"> <li>– Find and correct the cause of the foaming.</li> <li>– The process must be checked regularly in order to detect any foaming.</li> </ul> <p>See "Connected processing chemicals", "Soiling" and "Reactions between processing chemicals and soils" for more information.</p>
<p>Stainless steel corrosion in the wash compartment and/or accessories may appear in various ways:</p> <ul style="list-style-type: none"> <li>– rust formation (red spots / stains),</li> <li>– black spots / stains,</li> <li>– white spots / stains (smooth surface is slightly corroded).</li> </ul> <p>Corrosion that forms holes can result in leaks in the lab washer. Depending on the application, the corrosion may impair the cleaning and rinsing results (laboratory analysis) or cause corrosion of the load (stainless steel).</p>	<ul style="list-style-type: none"> <li>– Find and correct the cause of the corrosion.</li> </ul> <p>See "Connected processing chemicals", "Soiling" and "Reactions between processing chemicals and soils" for more information.</p>

# Effects of Processing Chemicals

## Connected processing chemicals

Effects	Action
<p>The ingredients of the processing chemicals have a considerable effect on the durability and functionality (feed performance) of the metering systems. The metering systems (feed hoses and pump) are designed for a specific type of processing chemicals.</p> <p>General categories:</p> <ul style="list-style-type: none"> <li>– alkaline to neutral pH products,</li> <li>– acid to neutral pH products,</li> <li>– hydrogen peroxide.</li> </ul>	<ul style="list-style-type: none"> <li>– Use only those processing chemicals recommended by Miele. Consult a Miele Applications Specialist.</li> <li>– Perform regular visual inspections of the metering system.</li> <li>– Regularly check the feed performance of the metering system.</li> </ul>
<p>The processing chemicals can damage the elastomer and plastic components of the lab washer and its accessories.</p>	<ul style="list-style-type: none"> <li>– Use only those processing chemicals recommended by Miele. Consult a Miele Applications Specialist.</li> <li>– Perform regular visual inspections of all visible elastomer and plastic components.</li> </ul>
<p>Hydrogen peroxide can release large quantities of oxygen.</p>	<ul style="list-style-type: none"> <li>– Use only tested processes such as OXIVARIO or OXIVARIO PLUS (if available).</li> <li>– In the case of hydrogen peroxide, the washing temperature should be below 158 °F (70 °C).</li> </ul> <p>Consult a Miele Applications Specialist.</p>

# Effects of Processing Chemicals

Connected processing chemicals	
Effects	Action
<p>The following processing chemicals can result in excessive foaming:</p> <ul style="list-style-type: none"> <li>– tenside cleaners containing detergent and rinse aid.</li> </ul> <p>The foaming can occur:</p> <ul style="list-style-type: none"> <li>– in the program block in which the processing chemical is added,</li> <li>– in the subsequent program block due to carry-over,</li> <li>– in the case of rinsing agents, in the subsequent program due to carry-over.</li> </ul>	<ul style="list-style-type: none"> <li>– The process parameters of the wash program, e.g. metering temperature, metering concentration, etc. must be set so that the overall process creates little or no foam.</li> <li>– Observe the instructions of the manufacturer of the processing chemicals.</li> </ul>
<p>Antifoaming agents, particularly silicone-based antifoaming agents, can cause the following:</p> <ul style="list-style-type: none"> <li>– deposits in the wash compartment,</li> <li>– deposits on the wash load,</li> <li>– damage to the elastomer and plastic components of the lab washer,</li> <li>– attack certain plastics (e.g. polycarbonates, plexiglass, etc.) in the wash load.</li> </ul>	<ul style="list-style-type: none"> <li>– Use antifoaming agents only in exceptional cases or when they are absolutely necessary for the process.</li> <li>– Periodic cleaning of the wash compartment and accessories without a load and without an antifoaming agent using the ORGANICA program (if available).</li> </ul> <p>Consult a Miele Applications Specialist.</p>

# Effects of Processing Chemicals

## Soiling

### Effects

The following substances can damage the elastomer components (hoses and seals) and, in some cases, the plastic components of the lab washer:

- oils, waxes, aromatic and unsaturated hydrocarbons,
- softeners,
- cosmetics, hygiene and skin care products such as creams (analysis and filling sections).

The following substances can cause excessive foaming during washing and rinsing:

- agents such as disinfection agents, dish detergents, etc.
- reagents for analysis, e.g. for microtitration plates,
- cosmetics, hygiene and skin care products such as creams (analysis and filling sections).
- foaming substances in general, for instance tensides.

The following substances can cause corrosion of the stainless steel in the wash compartment and accessories:

- hydrochloric acid,
- other substances that contain chloride, e.g. sodium chloride, etc.
- conc. sulphuric acid,
- chromic acid,
- iron particles.

### Action

- Retrofit the lab washer with more grease-resistant elastomers.
- Depending on what the lab washer is used for, periodically wipe the lower door seal with a lint-free cloth or sponge.  
Clean the wash compartment and accessories without a load using the ORGANICA program.
- To process the load, use the program "OIL" (if available) or use the special program with metering of tenside cleaners..

- First rinse the load with a sufficient quantity of water.
- Select a wash program with one or more short pre-rinses with cold or warm water.
- Taking the specific application into account, add an antifoaming agent, one without silicone oils if possible.

- First rinse the load with a sufficient quantity of water.
- Let the load drip dry before putting it on the carts, baskets and inserts and placing in the lab washer.

# Effects of Processing Chemicals

## Reactions between processing chemicals and soils

Effects	Action
Natural oils and greases can be saponified with alkaline processing chemicals. This may cause a lot of foaming.	<ul style="list-style-type: none"><li>- Use the program OIL (if available).</li><li>- Use the special program with dosing of tenside cleaners (neutral pH) for pre-rinsing.</li><li>- Taking the specific application into account, add an antifoaming agent, one without silicone oils if possible.</li></ul>
In combination with alkaline processing chemicals, loads with soiling that contains proteins, e.g. blood, can cause excessive foaming.	<ul style="list-style-type: none"><li>- Select a wash program with one or more short pre-rinses with cold water.</li></ul>
In combination with very acidic or alkaline processing chemicals, base metals such as aluminum, magnesium and zinc can release hydrogen (detonating gas).	<ul style="list-style-type: none"><li>- Observe the instructions of the manufacturer of the processing chemicals.</li></ul>



# Adding liquid detergents and neutralizers

 Use only detergents and neutralizers specially designed for lab washers. Always observe the manufacturer's recommendations for use. You must observe their information about toxicologically safe residues.

The lab washer can be fitted with a maximum of 5 internal dispensing systems. They are color-coded to match the dispensing pumps to the corresponding siphon tubes.

Dispensing system	Color coding
1	blue
2	white
3	red
4	green

Depending on the application(s) chosen for this machine, the appropriate amounts of detergent and neutralizer are dispensed through these systems.

The washer comes equipped, as standard, with two internal dispensing systems:

- Dispensing system DOS 1 (blue) for use with alkaline products, e.g., liquid detergents. The dosing rate is 200 ml/min.
- Dispensing system DOS 3 (red) for use with acidic products, e.g., neutralizers. The dosing rate is 105 ml/min.

Up to three additional dispensing systems can be installed optionally:

Dosing rate	Products
120 ml/min	alkaline
20 ml/min	acidic

The appropriate processing chemical containers are filled and placed into the upper drawer of the lab washer.

## Additional DOS modules (optional):

- Dispensing system DOS S 20 for dispensing acidic processing chemicals, e.g., neutralizers. The dosing rate is 20 ml/min.
- Dispensing system DOS NA 120 for dispensing low-foam, washer-compatible disinfection agents or an additional detergent. The dosing rate is 120 ml/min.

The containers for the optional dosing systems are placed into the lower drawer of the lab washer.

Always place two containers into the lower drawer, even if only one optional dosing system is retrofitted. This prevents the containers from tipping when the drawer is opened or closed.

If a dispensing system is to dispense different processing chemicals, the change of chemicals must be completed by Miele's Technical Service Department.

# Adding liquid detergents and neutralizers

## Dispensing systems

The liquid processing chemicals can be loaded into 5 l plastic containers, which are color-coded to match the respective dispensing system(s).

 Use caution when handling processing chemicals. These products can cause irritation and burning. Always follow all applicable safety procedures and observe the manufacturer's instructions. Use protective eye wear and gloves.

### Message "Fill DOS [X] container"

- Refill or replace the container indicated in the display.

Fill the container(s) when you are prompted in the display, e.g., **Fill DOS1 container**. This will prevent containers from becoming completely empty and needing to be primed (cleared of air).

## Adding liquid detergents and neutralizers

The DOS drawer houses the liquid processing chemical dispensers.

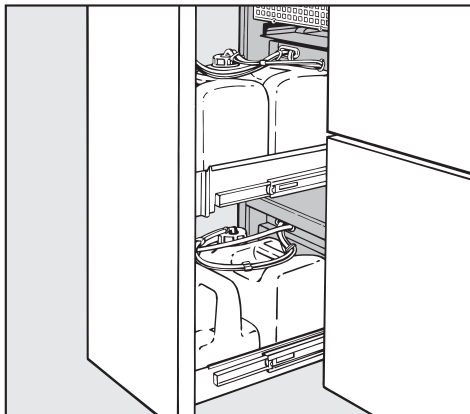

- Open the door and remove the containers from the lab washer.
- Open the container and fill with the appropriate processing chemicals. Be sure to comply with the color coding.

Once the containers have been filled, the message clears from the display.

- If the container is in the DOS drawer, make sure that the drawer is closed.

# Adding liquid detergents and neutralizers

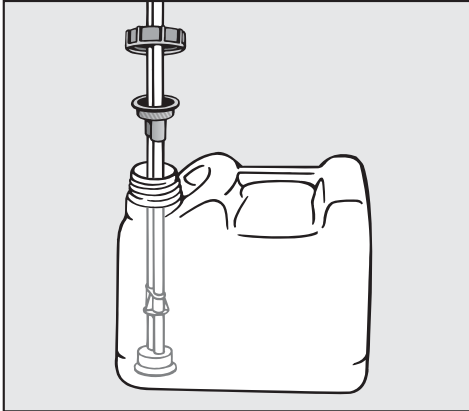

- Insert the siphon tube into the container opening and screw it into place. Make sure to observe the color coding.

Once the containers have been filled, the message clears from the display.

## Message "Check dispensing system [X]"

The currently running program pauses.

- Check the container(s) and dispensing hoses indicated in the display.  
Refill or replace as needed.

Containers and dispensing systems that are not in use can be shut off, to avoid fault messages in the display (see "Machine function - Container inquiry" in the Programming manual).

## Priming the dispensing system

Whenever a container has been allowed to completely empty, it must be primed (cleared of air) after refilling.

- Select the corresponding service program, e. g., **DOS1-FILL**.
- Press the  start button.

 The interrupted program must be restarted.

# Operation

---

## Turning On

- If closed, open the water supply.
- Press and hold the  button .

The activating time for the  button can be set to a maximum of 10 seconds (see "System functions - On/Off button activation time" in the Programming Manual).

- The last selected program is shown in the program overview on operating level A, B, and D and operating instructions for the **Automatic mobile unit recognition** are displayed in operating level C.

If the washer is not in use, the display automatically switches off after approx. 10 min.  
To turn the display back on, touch any button.

## Reset button

If the Profitronic no longer responds to the keys it can be restarted with the Reset button.

The Reset button is located at the underside of the electronic control. To activate it:

- Pull out the DOS drawer.
- Push the Reset button.

The Profitronic is shut down and restarted.



## Starting a program

You can find detailed and important information regarding the Miele default programs in the Program charts in the Appendix of the Programming Manual.

 Any program or dosing changes in connection with the preparation of medical devices must be documented (under the German Medical Device Operator Ordinance). In such cases, the lab washer results (cleaning, disinfection) will need to be re-validated.



## Operating levels A and B

A list of all selectable programs appears in the display.

- Select the desired program with  , confirm with **OK**.
- Press the  start button.

The program begins.

## Operating level D

- Select the menu item **Program overview**, confirm with **OK**.
- Select the desired program with  , confirm with **OK**.
- Press the  start button.

The program begins.

## Operating level C

 Make sure that no metallic parts or pieces are stuck to the magnetic strip or its underside. These objects can cause the coding to be misread or unreadable.

 Before pressing the start button to begin the program, it is essential to check that the program required **for this mobile unit** is the one shown in the display! Otherwise, inadequate cleaning and disinfection could result! Always make sure that the mobile units with automatic recognition (AWK) are properly coded.

- Push the coded basket into place in the washer.
- Close the door.
- Press the start button .

The program begins.

## Program sequence

Once started, the program proceeds automatically. The program steps are shown in the display.

Detailed information on the program sequences is available in the "Programming Manual".

## End of program

- Once the program ends, **End of program** appears in the display.

## Turning off

- Press the  button.

If the machine is to be left off for several days, be sure to disconnect it from the electrical and water supplies.

# Operation

---

## Cancel program

A program can only be interrupted or canceled in operating **levels B** and **D**.

### In operating levels B or D

- Press the **◀C** button.

The program is interrupted.

At water temperatures below 40 °C, the following message appears in the display:

**Program Cancel (OK)  
or Continue (Clear)?**

At water temperatures above 40 °C:

**Cancel program (OK)**

 If there is a large volume of hot water in the wash cabinet when a program is interrupted, and the lab washer door is closed too quickly, hot water can leak out. There is the risk of scalding and burning.

- Confirm the program cancellation with **OK**.

**Program canceled, Water drainage** appears in the display.

After the water has drained away, the program list returns to the display.

## Interrupting a program

A program can only be interrupted or canceled in operating **levels B** and **D**.

Only interrupt a program if the door must be opened for urgent reasons, e.g., if items are moving around too much, or the cleaning performance needs to be checked.

If a program with a defined process requirement is interrupted then continued, make sure to check the display upon program completion. If the display reads **Process parameter not achieved**, the door was opened **after** process parameter monitoring began, and so the defined requirements were not achieved. If necessary, repeat the program.

### In operating levels B or D

- Press the **◀C** button.

At water temperatures below 104°F (40 °C), the following message appears in the display:

**Program Cancel (OK)  
or Continue (Clear)?**

At water temperatures above 104°F (40 °C):

**Cancel program (OK)**

- Open door.

 **Caution!** Items in the machine may be hot. There is the danger of burning or scalding.

- Arrange items securely.
- Carefully close door.

 If there is a large volume of hot water in the wash cabinet when a program is interrupted, and the lab washer door is closed too quickly, hot water can leak out. There is the risk of scalding and burning.

If, at the time of program interruption, the water temperature was below 104°F (40 °C):

- Press the **◀C** button.

The program continues.

If, at the time of program interruption, the water temperature was above 104°F (40 °C):

- Press the **OK** button.

The program is canceled.

The display reads:

**Program canceled Water drainage.**

Once the water has drained away the program can be restarted.

# Process documentation

---

The lab washer provides the option to document the cleaning processes (process documentation). External process documentation software or an external printer can be used to output the process documentation.

The rear panel of the lab washer is equipped with two RJ45 sockets used for connecting process documentation software or a printer.

For instructions on how to configure the interface, refer to the section on PC/Printer functions in the "Programming Manual".

## Process documentation with external software

The "Ethernet" socket is intended for the transmission of process protocols and temperature curves to an external process documentation software.

An Ethernet cable (straight-through) is required for the Ethernet connection of the lab washer to suitable network components (e.g. hub, switch).

A twisted Ethernet cable (cross-over) is required for the direct Ethernet connection between the lab washer and an external device, e.g., a PC.

## Process documentation with external printer

The "Printer" plug is intended for connecting an external printer to a serial interface.

An RJ45 / Sub-D adapter plug is supplied for the connection of the lab washer to an external printer via an RS 232 interface.

For instructions on how to set the external printer functions, refer to the section on PC/Printer functions in the "Programming Manual".

When connecting a printer or PC, please note the following:

- use only approved printers,
- select a printer or PC that is suited to the installation application,
- the length of the extension cord from the serial interface to the printer or PC must not exceed 32' 10" (10 m), and 328' (100 m) from the Ethernet interface.

For more information regarding suitable printers and software solutions, please contact Miele.



Periodical maintenance for this lab washer is offered by Miele Professional Technical Service.

**After 1000 operating hours or at least once a year is the recommended interval.**

The maintenance covers the following:

- Electrical safety
- Door mechanism and door seal
- Threads and connections in the wash cabinet
- Water inlet and drain
- Internal and external dispensing systems
- Spray arms
- Triple Filter System
- Drain pump and non-return faucet
- Steam condenser:
- All mobile units, baskets and inserts

If available:

- Connected printer

Part of the maintenance is a function check:

- A program is run as a test
- A thermoelectrical measurement
- A leak tightness check
- All safety relevant measuring systems (Display of faults)

Contact Miele Professional Technical Service at 800-991-9380 for details.

## Routine checks

The routine checks must be done daily by the user before using the machine. For the routine checks a checklist is equipped with the washer.

Check the following points:

- the filters in the base of the wash cabinet,
- the spray arms in the machine and at the mobile units and inserts,
- the wash cabinet and the door seal,
- the mobile units, baskets and inserts, and
- all safety equipment.

# Maintenance

## Cleaning the filters in the wash cabinet

The filters in the base of the wash cabinet are designed to prevent coarse soils from getting into the circulation system.

A build-up of these soils can cause the filters to clog. They should be checked routinely and cleaned if necessary.

 DO NOT use the machine without all filters in place.

 Watch out for glass splinters, needles etc. which could cause injury.

## Cleaning the coarse filter

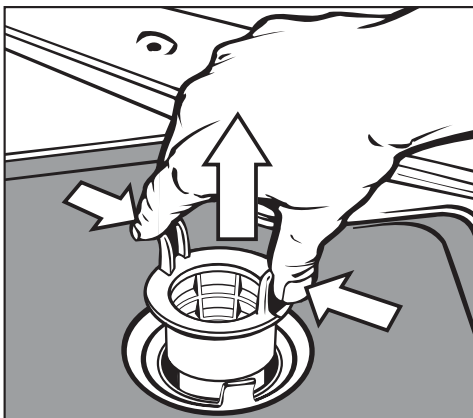

- Press the two lugs together, remove, and clean the coarse filter.
- Put the clean filter back in position and press down until it clicks in place.

## Cleaning the flat and micro-fine filters

- Remove the coarse filter.
- Remove the fine filter (not shown) which sits inside of the micro-fine filter.

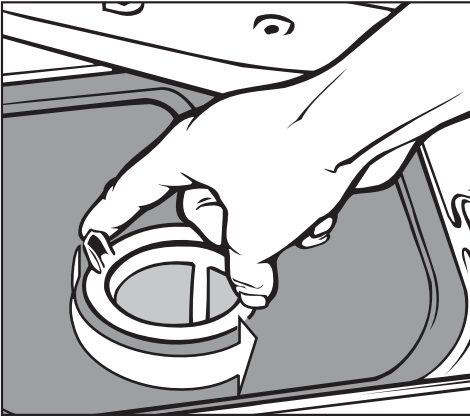

- To unscrew the micro-fine filter, turn twice counterclockwise.

 Watch out for glass splinters, needles etc. which could cause injury.

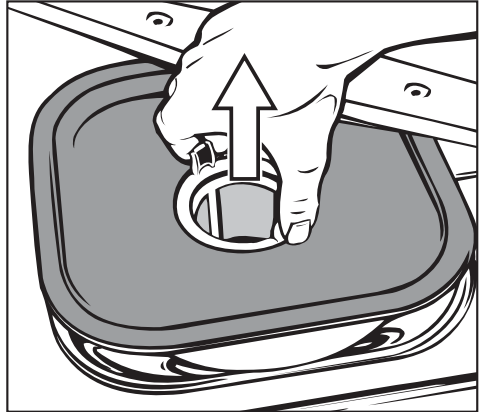

- Then pull out the micro-fine filter together with the flat filter.
- Clean the filters.
- Replace the filters by performing the above steps in the reverse order. Ensure that the filters sit flat in the base of the wash cabinet.

# Maintenance

---

## Cleaning the spray arms

The water jets in the spray arms can become blocked and should be checked periodically.

Remove the spray arms as follows:

- Take any baskets out of the wash cabinet.

### For spray arms on the bottom of top baskets or mobile units:

- Loosen the nut on the spray arm and take the spray arm off.

Metal nuts have a reverse thread, while ceramic nuts have a regular thread.

### For spray arms inside of the wash cabinet:

- Unscrew the **upper** spray arm.
- Loosen the knurled thumb nut to unscrew the **lower** spray arm.
- Use a pointed object to push particles into the spray arm jets, and then rinse well under running water.
- After cleaning the spray arms, fit them and screw them back into position.

After replacing the spray arms, check that they rotate freely.

## Cleaning the control panel and glass door (optional)

- Press ① to turn off the washer.
- Clean the control panel and the glass door with a damp cloth or glass cleaner.  
To disinfect, use an approved cleaning agent.

 Do not use abrasive or all-purpose cleaners. The chemicals contained in these products can seriously damage the surface of the glass.

## Cleaning the exterior

- To clean the stainless steel exterior, use a damp cloth and dish soap, or a non-abrasive stainless steel cleaner.
- To help prevent re-soiling (fingerprints, etc.), a stainless steel conditioner can be used after cleaning.

 Do not use thinner or ammonium-based cleaners. They can damage the surface.

 Do not hose down the washer or the immediate vicinity, e.g., with a water hose or pressure washer.

## Cleaning the wash cabinet

The wash cabinet is mostly self-cleaning.  
If you notice a build-up of deposits, contact Miele.

## Cleaning the door seal

To remove soiling, clean the door seal regularly with a damp cloth.

Damaged or leaky door seals should be replaced by Miele Technical Service.

# Maintenance

---

## Baskets and inserts

To ensure that the mobile units, baskets and inserts function properly, they must be checked routinely. A checklist is supplied with the lab washer.

Check the following points:

- Are the rollers in proper condition, and are they securely attached to the basket / insert?
- Are the counter-nuts on the guide rails firmly secured?
- Is the basket connection correctly set and firmly screwed on?
- For baskets in the modular system, are the caps in the module connection working properly?
- Are all spray jets, spray sleeves, and hose adapters securely attached to the basket / insert?
- Are all spray jets, spray sleeves, and hose adapters unclogged so that wash water can flow through?
- Are all caps, covers, and fasteners securely attached to the spray sleeves?

If there are spray arms:

- Do the spray arms rotate freely?
- Are the spray jets clogged? See the section on "Cleaning and Care / Cleaning the spray arms".
- Are the magnets in place on the spray arm ends?
- Are the magnets on the spray arms free of attached metal parts?
- Are the magnetic strips of the mobile unit free of any metallic items?
- Are the screws in the magnet rails for Automatic Mobile Unit Recognition tightly secured?

In addition to the periodic maintenance of the lab washer after 1000 operating hours or at least once a year, the mobile units, baskets and inserts also need to be maintained.

See "Maintenance - Routine checks".

## Drying unit maintenance

### How to change the coarse filter

If **Change coarse filter** appears in the display, the coarse filter needs to be replaced.

- Pull open the control cabinet drawer.

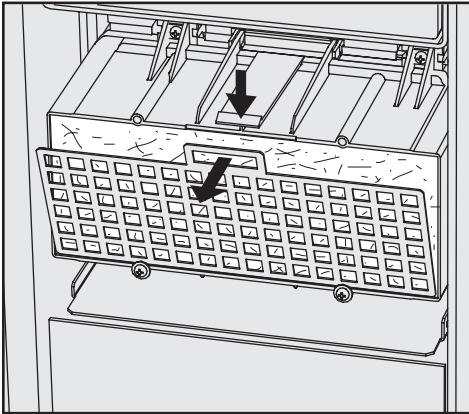

- Remove the filter mesh at the front of the drying unit.

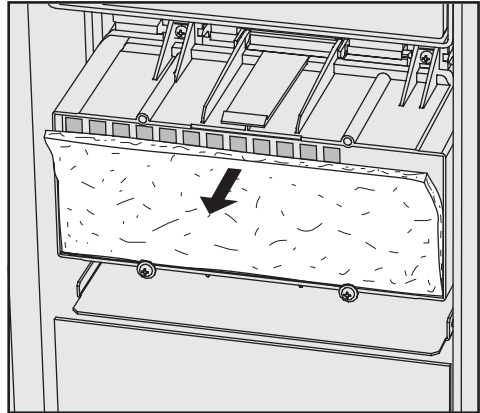

- Change the coarse filter. The soft side of the filter must face the front.
- Re-insert the filter mesh at the bottom, then press it into place at the top.
- Close the control cabinet drawer.

After changing the coarse filter, you must reset the operating hours counter.

To do so:

- Select **CHANGE DS-COARSE** and start the program by pressing the **◇** button.

When the service program has finished, the display will show a message.

- Confirm this message with **OK**.

The system displays the program overview.

# Maintenance

## Changing the fine filter

- If **Change fine filter** appears in the display, the HEPA filter needs to be replaced.

To ensure optimal performance, use only **original Miele HEPA filters** (classification 13).

It is best to have the fine (HEPA) filter replaced directly by Miele during routine maintenance.

If that is not possible, the fine filter can be changed as follows:

- Pull open the control cabinet drawer.
- Unscrew the upper screws on the coarse filter housing and lift upward.

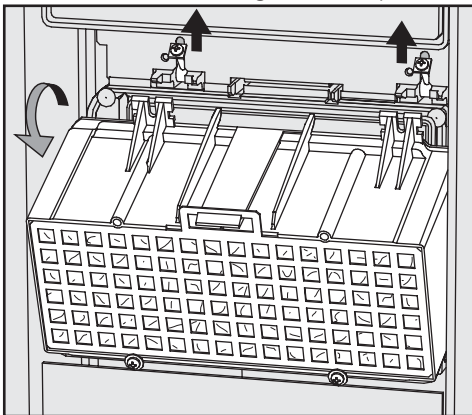

- Remove the coarse filter housing.

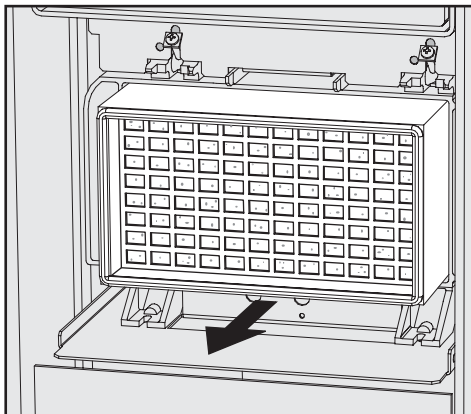

- Remove the fine filter and insert a new one.
- Reinsert the coarse filter housing and flip the screws downward.
- Tighten the screws.
- Close the control cabinet drawer.

After changing the HEPA filter, you must reset the operating hours counter.

To do so:

- Select **CHANGE DS-FINE** and start the program by pressing the  $\diamond$  button.

When the service program has finished, the display will show a message.

- Confirm this message with **OK**.

The system displays the program overview.



Repairs should only be carried out by a qualified and trained person in accordance with local and national safety regulations. Unauthorized repairs could cause personal injury or machine damage. In the event of any problems which cannot be corrected, please contact the Miele Technical Service Department.

Messages regarding the operating status of the machine and fault messages are shown in the display.

**The fault table is supplied in the Programming Manual under "Messages".**

### Heater limiter

This machine has a resettable heater limiter which will shut off the elements in the event of over-heating. This could be caused for example, if large articles cover the heating elements or if the filters in the wash cabinet are blocked.

If the message "CHECK WASH CABINET HEATING" is displayed (water has not heated up in the wash cabinet and the program takes too long):

- Isolate and correct the cause of the problem.
- Remove the service panel (see "Electrical connection").
- Press the RESET button on the temperature sensor located on the right side of the machine.

**If this switch trips repeatedly, contact the Miele Technical Service before using the machine again.**

# Frequently asked questions

## Cleaning the water intake filters

Filters are incorporated in water intake connections to protect the intake valves. If these filters get dirty they need to be cleaned, or sufficient water may not flow into the wash cabinet.

 The plastic housing of the water connection contains an electrical component. It must not be dipped in water.

## To clean the filters

- Disconnect the machine from the power supply.

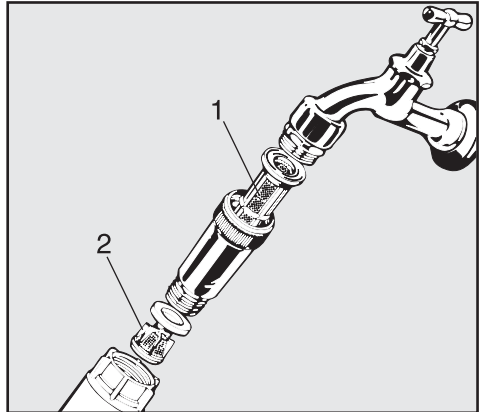

- Turn off the water valve and unscrew the water intake hose.
- Check and/or replace the rubber washer if necessary.
- Clean the large area filter (1) and fine filter (2), and/or replace with new filters if necessary.
- Make sure they are seated correctly.
- Reconnect the hose to the valve, making sure it goes on correctly and is not cross-threaded.

Open the valve gradually to test for leaks.

If there is a leak, the hose might not be on securely or it may have been screwed on at an angle.

- Unscrew and reconnect it to the water valve correctly.

 This lab washer must be installed, maintained and repaired by an authorized Miele service technician. Maintenance and repair work performed by unqualified persons can place the user at risk.

In the event of a fault which you cannot correct yourself please contact the Miele Technical Service Department



1-800-991-9380

[techserv@mieleusa.com](mailto:techserv@mieleusa.com)

Please quote the model of your lab washer. This information can be found on the lab washer's front panel.



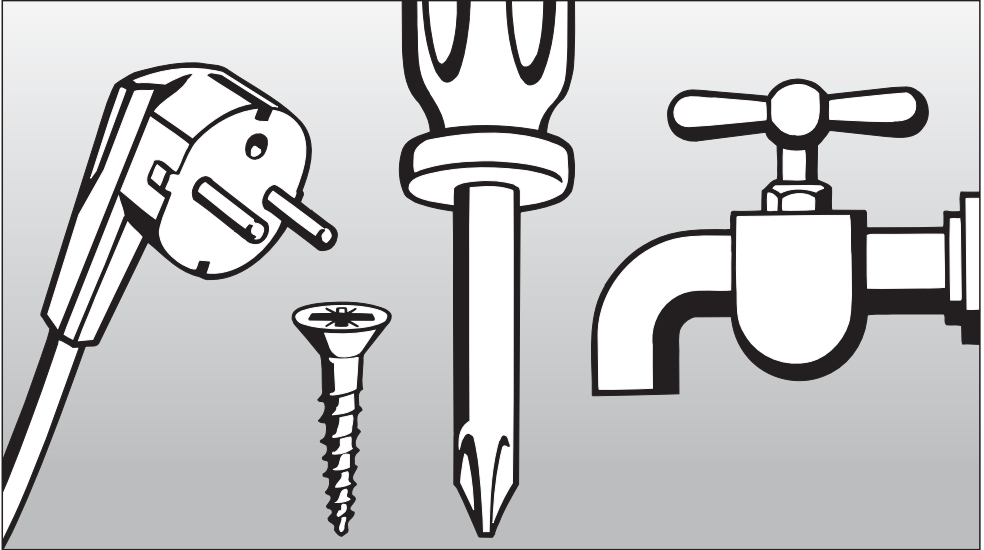

## INSTALLATION INSTRUCTIONS

Information is subject to change. Please refer to our website to obtain the most current product specification, technical & warranty information.

To prevent accidents  
and machine damage  
read these instructions  
**before**  
installation or use.

# Installation

---

 Please refer to the installation diagram supplied with the machine.

 Furniture and fittings installed near the machine must be of a commercial standard able to withstand the effects of steam and condensed water.

## Leveling the machine

The machine must be installed correctly and leveled.

Any unevenness in the floor level can be compensated for and the height of the machine raised or lowered by adjusting the four screw feet.

 All electrical work must be carried out by a qualified electrician in accordance with local and national safety regulations.

- Connection should be made via a suitable isolator, with an On/Off switch that is easily accessible for servicing work.
- The electrical connection is made through a receptacle according to national requirements. The receptacle has to be easily accessible after installation.
- For technical data see the data plate or wiring diagram supplied.

The machine is equipped with a 6 ft. (1.8 m) long power cord, without a plug. A plug, rated for the required power which will fit the receptacle, is to be supplied by the electrician doing the installation. It should be connected to the main power supply.

The machine must only be operated with the voltage, frequency and fusing shown on the data plate.

The machine can be converted according to the converting diagram and wiring diagram.

The converting diagram and data plate are located on the rear of the machine, and on the plinth (behind the service panel).

The wiring diagram is supplied with the machine.

- See the supplied installation diagram. Contact Miele Technical Service for more information.

A damaged power cord must only be replaced with a genuine Miele cord by a Miele service technician.

### **WARNING** **THIS APPLIANCE MUST BE GROUNDED**

#### **Grounding connection**

The ground lead must be connected to the screw connection point (marked with the ground symbol  $\downarrow$ ) at the back of the machine.

# Plumbing

---

## Water connection

This machine must be connected to the water supply in accordance with all national and local plumbing codes.

 **Water in the machine is not suitable for drinking.**

- The machine must be connected to the water supply in accordance with local and national regulations.
- The water being used should have drinking water quality.  
A high iron content can lead to rust at the items to be cleaned and at the machine.  
At a chloride content of more than 100mg/l there is a higher risk of corrosion for the items to be cleaned.

## Water supply pressure

Hot + Cold water connection =  
min. 22 psi - max. 145 psi  
DI water connection =  
min. 9 psi - max. 145 psi

## Recommended water pressure

Hot + Cold water connection =  
over 37 psi - max. 145 psi  
DI water connection =  
over 22 psi - max. 145 psi  
to avoid long intake times

- The maximum permissible static water pressure is 145 psi.
- If the water pressure lies outside the range of 22-145 psi, please contact Miele for advice.

- The machine is designed for connection to cold water (blue marking) and hot water (red marking) up to 70°C max. Connect the water intake hoses to the cold and hot water shut-off faucets. Connect the intake hose for the steam condenser (without water control system) to the cold water faucet.
- If there is no hot water line, the red marked hose must also be connected to the cold water line. See the next page for how to connect the DI water line ("H<sub>2</sub>O pur").
- Water faucets with 3/4" male thread are to be provided on site. Faucets and drain connections should be situated as close to the machine as possible, and be easily accessible.
- The DN 10 inlet hoses are approx. 5ft. 7" (1.7 m) long terminating in a 3/4" female thread. The water inlet filters in the threads must not be removed. Water connection 70
- Large area filters, supplied with the machine, are to be installed in the hose attached to the water supply (see illustration in "Cleaning and Care - Cleaning the water inlet filters"). The large surface area filter for DI water is made of stainless steel and can be recognized by the matte surface.



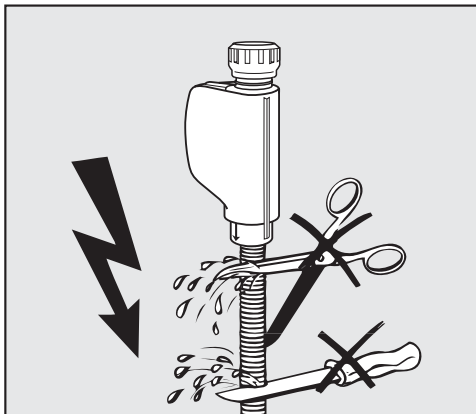

 Do not shorten or damage the hoses.

See the enclosed installation plan.

## **DI water connection (pressure-resistant) 9 - 145 psi**

The machine is equipped for connection to a pressure-resistant system at 9 - 145 psi. If the water pressure (inflow pressure) is below 22 psi, the water intake time is automatically extended.

- Connect the DI hose (pressure-tested and marked with "H2O pur") with 3/4 inch thread to the DI water shut-off faucet.

 If the machine will not be connected to DI water, the cleaning and disinfection programs must be changed by Miele Technical Service. The intake hose stays at the rear of the machine.

## **DI water connection (pressureless) 1.25 - 9 psi (optional)**

For connection to 1.25 - 9 psi water pressure the machine must be converted if it was not ordered from the factory as a special model. A feed pump must be installed by Miele.

The discharge nipple of the DI water container (pressureless) must be at least at the same height as the machine's upper edge.

# Plumbing

---

## Drainage

Connection to the drainage system and disposal of waste water must comply with local and national regulations.

- The drainage system is fitted with a non-return valve which prevents waste water from flowing back into the machine via the drain hose.
- The machine should preferably be connected to a separate drainage system onsite.  
If **separate** drainage is not available, contact your Miele application specialist for advice.  
The on-site connection needs to be between 2 ft. (0.6 m) and 3 ft 3" (1 m) high **measured from the lower edge of the machine.**
- The flexible drain hose is 4 ft 11" (1.5 m) long. The clearance is  $\frac{7}{8}$ " (22 mm). **Do not cut the drain hose.** Hose clamps for installation are enclosed.
- A longer drain hose (up to 13 ft [4 m] long) is available to order from the Miele Technical Service Department.
- The drainage system must not exceed 13 ft [4 m] .

See also the installation diagram supplied.

## Technical Data

	English	Metric
Height:	46 1/4"	117.5 cm
Width:	35 3/8"	90 cm
Depth:	27 1/2"	70 cm
Depth with the door open:	49 3/4"	126.5 cm
Net weight:	397 lbs	180 kg
Connection data:	see data plate	
Power cord	approx. 5' 11"	1.8 m
Water temperature:		
Cold water	max. 68°F	20 °C
Hot and DI water connection	max. 158° F	70 °C
Static water pressure:	max. 145 psi	
Minimum flow pressure		
Hot and cold water connection:	21.75 psi	
DI water connection	: 8.7 psi	
Recommended flow pressure		
Hot and cold water connection:	over 36.25 psi	
DI water connection :	over 21.75 psi	
DI Water Connection (pressureless)		
optional	1.23 - 8.70 psi	
Delivery head:	min. 23 5/8" (0.6 m), max. 39 3/8" (1 m)	
Steam condenser:	approx. 2 - 4 l/min	
Surrounding temperature:	between 41°F - 104°F (5°C to 40°C)	
Max. relative humidity	80% for temperature up to 88°F (31°C)	
Linear reduction up to	50% for temperature up to 104°F (40°C)	
Height above sea level:	up to 4921 ft. (1500 m)*	
Noise level in dB (A):		
Sound pressure level LpA during washing and drying	<70	
Test marks:	CSA	
CE-mark:	MPG-Guidelines 93/42/EWG, Class IIb	
Manufacturer's address	Miele & Cie. KG, Carl-Miele-Straße 29, 33332 Gütersloh, Germany	

# Caring for the environment

---

## **Disposal of the packing materials**

The cardboard box and packing materials protect the appliance during shipping. They have been designed to be biodegradable and recyclable.

Ensure that any plastic wrappings, bags, etc. are disposed of safely and kept out of the reach of children.

Danger of suffocation! Please recycle.

## **Disposal of an old appliance**

Old appliances may contain materials that can be recycled. Please contact your local authorities about recycling in your area.

Ensure that the appliance presents no danger to children while being stored for disposal. See "Important Safety Instructions".







**Please have the model and serial number  
of your appliance available before  
contacting Technical Service.**

---

**Miele**  
**PROFESSIONAL**

## **U.S.A.**

**Miele, Inc.**

### **National Headquarters**

9 Independence Way  
Princeton, NJ 08540  
Phone: 800-991-9380  
609-419-9898  
Fax: 609-419-4241  
[www.mieleusa.com](http://www.mieleusa.com)

### **Technical Service & Support Nationwide**

Phone: 800-991-9380  
Fax: 800-220-1348

[proservice@mieleusa.com](mailto:proservice@mieleusa.com)

## **Germany**

Miele & Cie. KG  
Carl-Miele-Straße 29  
33332 Gütersloh

